

+ ROLLING BEARINGS



THRUST BEARINGS

SINGLE-DIRECTION THRUST BALL BEARINGS

With Flat Seat, Aligning Seat, or Aligning Seat Washer Bore Diameter 10 – 100mm B206
 Bore Diameter 110 – 360mm B210

DOUBLE-DIRECTION THRUST BALL BEARINGS

With Flat Seat, Aligning Seat, or Aligning Seat Washer Bore Diameter 10 – 190mm B214

CYLINDRICAL ROLLER THRUST BEARINGS Bore Diameter 35 – 320mm B220

SPHERICAL THRUST ROLLER BEARINGS Bore Diameter 60 – 500mm B224

Angular Contact Thrust Ball Bearings are described on pages B230 to B239.



DESIGN, TYPES, AND FEATURES

THRUST BALL BEARINGS

Thrust ball bearings are classified into those with flat seats or aligning seats depending on the shape of the outer ring seat (housing washer). They can sustain axial loads but no radial loads.

The series of thrust ball bearings available are shown in Table 1. For Single-Direction Thrust Ball Bearings, pressed steel cages and machined brass cages are usually used as shown in Table 2. The cages in Double-Direction Thrust Ball Bearings are the same as those in Single-Direction Thrust Ball Bearings of the same diameter series.

The basic load ratings listed in the bearing tables are based on the standard cage type shown in Table 2. If the type of cage is different for bearings with the same number, the number of balls may vary, in such a case, the load rating will differ from the one listed in the bearing tables.

Table 1 Series of Thrust Ball Bearings

	W/Flat Seat	W/Aligning Seat	W/Aligning Seat Washer
Single-Direction	511	—	—
	512	532	532U
	513	533	533U
	514	534	534U
Double-Direction	522	542	542U
	523	543	543U
	524	544	544U

Table 2 Standard Cages for Thrust Ball Bearings

Pressed Steel	Machined Brass
51100 – 51152X 51200 – 51236X 51305 – 51336X	51156X – 51172X 51238X – 51272X 51338X – 51340X
51405 – 51418X 53200 – 53236X 53305 – 53336X 53405 – 53418X	51420X – 51436X 53238X – 53272X 53338X – 53340X 53420X – 53436X

CYLINDRICAL ROLLER THRUST BEARINGS

These are thrust bearings containing cylindrical rollers. They can sustain only axial loads, but they are suitable for heavy loads and have high axial rigidity.

The cages are machined brass.

SPHERICAL THRUST ROLLER BEARINGS

These are thrust bearings containing convex rollers. They have a self-aligning capability and are free of any influence of mounting error or shaft deflection. Besides the original type, the E type with pressed cages for high load capacity is also available. Their bearing numbers are suffixed by E.

For horizontal shaft or high speed application, machined brass cages are recommended. For details, contact NSK.

Since there are several places where lubrication is difficult, such as the area between the roller heads and inner ring rib, the sliding surfaces between cage and guide sleeve, etc., oil lubrication should be used even at low speed.

The cages in the original type are machined brass.

TOLERANCES AND RUNNING ACCURACY

THRUST BALL BEARINGSTable 8.6 (Pages A72 to A74)

CYLINDRICAL ROLLER THRUST BEARINGS
.....According to Table 8.2 (Pages A72 to A74)

SPHERICAL THRUST ROLLER BEARINGSTable 8.7 (Pages A75)

RECOMMENDED FITS

THRUST BALL BEARINGSTable 9.3 (Pages A84)

Table 9.5 (Pages A85)

CYLINDRICAL ROLLER THRUST BEARINGSTable 9.3 (Pages A84)

Table 9.5 (Pages A85)

SPHERICAL THRUST ROLLER BEARINGSTable 9.3 (Pages A84)

Table 9.5 (Pages A85)

DIMENSIONS RELATED TO MOUNTING

The dimensions related to mounting of spherical thrust roller bearings are listed in the Bearing Table.

If the bearing load is heavy, it is necessary to design the shaft shoulder with ample strength in order to provide sufficient support for the shaft washer.

PERMISSIBLE MISALIGNMENT

The permissible misalignment of Spherical Thrust Roller Bearings varies depending on the size, but it is approximately 0.018 to 0.036 radian (1° to 2°) with average loads.

MINIMUM AXIAL LOAD

It is necessary to apply some axial load to thrust bearings to prevent slippage between the rolling elements and raceways. For more details, please refer to Page A99.

SINGLE-DIRECTION THRUST BALL BEARINGS

Bore Diameter 10 – 50 mm

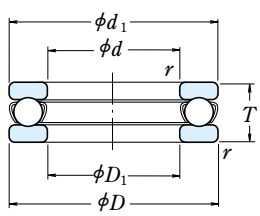

With Flat Seat

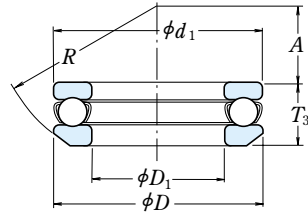

With Aligning Seat

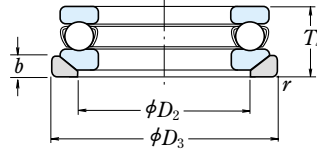

With Aligning Seat Washer

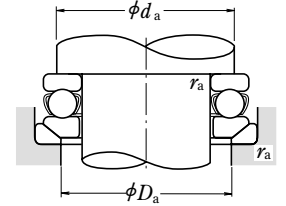
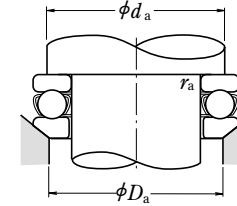
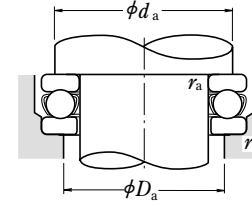

d	Boundary Dimensions (mm)					Basic Load Ratings (N)				Limiting Speeds (min ⁻¹)		With Flat Seat
	D	T	T ₃	T ₄	r _{min}	C _a	C _{0a}	C _a	C _{0a}	Grease	Oil	
10	24	9	—	—	0.3	10 100	14 000	1 030	1 420	6 700	10 000	51100
	26	11	11.6	13	0.6	12 800	17 100	1 300	1 740	6 000	9 000	51200
12	26	9	—	—	0.3	10 400	15 400	1 060	1 570	6 700	10 000	51101
	28	11	11.4	13	0.6	13 300	19 000	1 350	1 940	5 600	8 500	51201
15	28	9	—	—	0.3	10 600	16 800	1 080	1 710	6 300	9 500	51102
	32	12	13.3	15	0.6	16 700	24 800	1 710	2 530	5 000	7 500	51202
17	30	9	—	—	0.3	11 400	19 500	1 170	1 990	6 000	9 000	51103
	35	12	13.2	15	0.6	17 300	27 300	1 760	2 780	4 800	7 500	51203
20	35	10	—	—	0.3	15 100	26 600	1 540	2 710	5 300	8 000	51104
	40	14	14.7	17	0.6	22 500	37 500	2 290	3 850	4 300	6 300	51204
25	42	11	—	—	0.6	19 700	37 000	2 010	3 800	4 800	7 100	51105
	47	15	16.7	19	0.6	28 000	50 500	2 860	5 150	3 800	5 600	51205
	52	18	19.8	22	1	36 000	61 500	3 650	6 250	3 200	5 000	51305
	60	24	26.4	29	1	56 000	89 500	5 700	9 100	2 600	4 000	51405
30	47	11	—	—	0.6	20 600	42 000	2 100	4 300	4 300	6 700	51106
	52	16	17.8	20	0.6	29 500	58 000	3 000	5 950	3 400	5 300	51206
	60	21	22.6	25	1	43 000	78 500	4 400	8 000	2 800	4 300	51306
	70	28	30.1	33	1	73 000	126 000	7 450	12 800	2 200	3 400	51406
35	52	12	—	—	0.6	22 100	49 500	2 250	5 050	4 000	6 000	51107
	62	18	19.9	22	1	39 500	78 000	4 050	7 950	3 000	4 500	51207
	68	24	25.6	28	1	56 000	105 000	5 700	10 700	2 400	3 800	51307
	80	32	34	37	1.1	87 500	155 000	8 950	15 800	2 000	3 000	51407
40	60	13	—	—	0.6	27 100	63 000	2 770	6 400	3 600	5 300	51108
	68	19	20.3	23	1	47 500	98 500	4 850	10 000	2 800	4 300	51208
	78	26	28.5	31	1	70 000	135 000	7 100	13 700	2 200	3 400	51308
	90	36	38.2	42	1.1	103 000	188 000	10 500	19 100	1 700	2 600	51408
45	65	14	—	—	0.6	28 100	69 000	2 860	7 050	3 400	5 000	51109
	73	20	21.3	24	1	48 000	105 000	4 900	10 700	2 600	4 000	51209
	85	28	30.1	33	1	80 500	163 000	8 200	16 700	2 000	3 000	51309
	100	39	42.4	46	1.1	128 000	246 000	13 000	25 100	1 600	2 400	51409
50	70	14	—	—	0.6	29 000	75 500	2 960	7 700	3 200	4 800	51110
	78	22	23.5	26	1	49 000	111 000	5 000	11 400	2 400	3 600	51210
	95	31	34.3	37	1.1	97 500	202 000	9 950	20 600	1 800	2 800	51310
	110	43	45.6	50	1.5	147 000	288 000	15 000	29 400	1 400	2 200	51410

Bearing Numbers		Dimensions (mm)							Abutment and Fillet Dimensions (mm)			Mass(kg) approx		
With Aligning Seat	With Aligning Seat Washer	d ₁	D ₁	D ₂	D ₃	b	A	R	d _a min	D _a max	r _a max	With Flat Seat	With Aligning Seat	With Aligning Seat Washer
—	—	24	11	—	—	—	—	—	18	16	0.3	0.019	—	—
53200	53200 U	26	12	18	28	3.5	8.5	22	20	16	0.6	0.028	0.029	0.036
—	—	26	13	—	—	—	—	—	20	18	0.3	0.021	—	—
53201	53201 U	28	14	20	30	3.5	11.5	25	22	18	0.6	0.031	0.031	0.039
—	—	28	16	—	—	—	—	—	23	20	0.3	0.023	—	—
53202	53202 U	32	17	24	35	4	12	28	25	22	0.6	0.043	0.048	0.059
—	—	30	18	—	—	—	—	—	25	22	0.3	0.025	—	—
53203	53203 U	35	19	26	38	4	16	32	28	24	0.6	0.050	0.055	0.069
—	—	35	21	—	—	—	—	—	29	26	0.3	0.037	—	—
53204	53204 U	40	22	30	42	5	18	36	32	28	0.6	0.077	0.080	0.096
—	—	42	26	—	—	—	—	—	35	32	0.6	0.056	—	—
53205	53205 U	47	27	36	50	5.5	19	40	38	34	0.6	0.111	0.123	0.151
53305	53305 U	52	27	38	55	6	21	45	41	36	1	0.169	0.182	0.224
53405	53405 U	60	27	42	62	8	19	50	46	39	1	0.334	0.353	0.426
—	—	47	32	—	—	—	—	—	40	37	0.6	0.064	—	—
53206	53206 U	52	32	42	55	5.5	22	45	43	39	0.6	0.137	0.154	0.183
53306	53306 U	60	32	45	62	7	22	50	48	42	1	0.267	0.28	0.336
53406	53406 U	70	32	50	75	9	20	56	54	46	1	0.519	0.535	0.666
—	—	52	37	—	—	—	—	—	45	42	0.6	0.081	—	—
53207	53207 U	62	37	48	65	7	24	50	51	46	1	0.21	0.231	0.292
53307	53307 U	68	37	52	72	7.5	24	56	55	48	1	0.386	0.403	0.488
53407	53407 U	80	37	58	85	10	23	64	62	53	1	0.769	0.785	0.967
—	—	60	42	—	—	—	—	—	52	48	0.6	0.12	—	—
53208	53208 U	68	42	55	72	7	28.5	56	57	51	1	0.27	0.289	0.355
53308	53308 U	78	42	60	82	8.5	28	64	63	55	1	0.536	0.581	0.704
53408	53408 U	90	42	65	95	12	26	72	70	60	1	1.1	1.12	1.38
—	—	65	47	—	—	—	—	—	57	53	0.6	0.143	—	—
53209	53209 U	73	47	60	78	7.5	26	56	62	56	1	0.31	0.333	0.419
53309	53309 U	85	47	65	90	10	25	64	69	61	1	0.672	0.702	0.888
53409	53409 U	100	47	72	105	12.5	29	80	78	67	1	1.46	1.53	1.87
—	—	70	52	—	—	—	—	—	62	58	0.6	0.153	—	—
53210	53210 U	78	52	62	82	7.5	32.5	64	67	61	1	0.378	0.404	0.504
53310	53310 U	95	52	72	100	11	28	72	77	68	1	0.931	1.01	1.27
53410	53410 U	110	52	80	115	14	35	90	86	74	1.5	1.94	1.98	2.41

Bore Diameter 55 – 100 mm

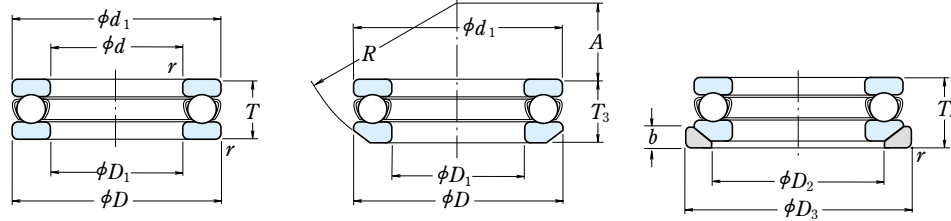

With Flat Seat

With Aligning Seat

With Aligning Seat Washer

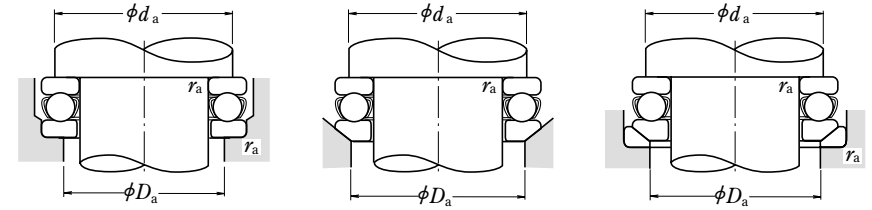

d	Boundary Dimensions (mm)						Basic Load Ratings (kgf)				Limiting Speeds (min ⁻¹)		With Flat Seat
	D	T	T_3	T_4	r_{\min}	C_a	C_{0a}	C_a	C_{0a}	Grease	Oil		
55	78	16	—	—	0.6	35 000	93 000	3 600	9 500	2 800	4 300	51111	
	90	25	27.3	30	1	70 000	159 000	7 150	16 200	2 200	3 200	51211	
	105	35	39.3	42	1.1	115 000	244 000	11 800	24 900	1 600	2 400	51311	
	120	48	50.5	55	1.5	181 000	350 000	18 500	35 500	1 300	1 900	51411	
60	85	17	—	—	1	41 500	113 000	4 250	11 500	2 600	4 000	51112	
	95	26	28	31	1	71 500	169 000	7 300	17 200	2 000	3 000	51212	
	110	35	38.3	42	1.1	119 000	263 000	12 100	26 800	1 600	2 400	51312	
	130	51	54	58	1.5	202 000	395 000	20 600	40 500	1 200	1 800	51412	
65	90	18	—	—	1	42 000	117 000	4 300	12 000	2 400	3 800	51113	
	100	27	28.7	32	1	75 500	189 000	7 700	19 200	1 900	2 800	51213	
	115	36	39.4	43	1.1	123 000	282 000	12 500	28 700	1 500	2 400	51313	
	140	56	60.2	65	2	234 000	495 000	23 800	50 500	1 100	1 700	51413	
70	95	18	—	—	1	43 500	127 000	4 450	12 900	2 400	3 600	51114	
	105	27	28.8	32	1	74 000	189 000	7 550	19 200	1 900	2 800	51214	
	125	40	44.2	48	1.1	137 000	315 000	14 000	32 000	1 400	2 000	51314	
	150	60	63.6	69	2	252 000	555 000	25 700	56 500	1 000	1 500	51414	
75	100	19	—	—	1	43 500	131 000	4 450	13 400	2 200	3 400	51115	
	110	27	28.3	32	1	78 000	209 000	7 950	21 300	1 800	2 800	51215	
	135	44	48.1	52	1.5	159 000	365 000	16 200	37 500	1 300	1 900	51315	
	160	65	69	75	2	254 000	560 000	25 900	57 000	950	1 400	51415	
80	105	19	—	—	1	45 000	141 000	4 600	14 400	2 200	3 400	51116	
	115	28	29.5	33	1	79 000	218 000	8 050	22 300	1 800	2 600	51216	
	140	44	47.6	52	1.5	164 000	395 000	16 700	40 000	1 300	1 900	51316	
	170	68	72.2	78	2.1	272 000	620 000	27 800	63 500	900	1 300	51416	
85	110	19	—	—	1	46 500	150 000	4 700	15 300	2 200	3 200	51117	
	125	31	33.1	37	1	96 000	264 000	9 800	26 900	1 600	2 400	51217	
	150	49	53.1	58	1.5	207 000	490 000	21 100	50 000	1 100	1 700	51317	
	180	72	77	83	2.1	310 000	755 000	31 500	77 000	850	1 300	51417 X	
90	120	22	—	—	1	60 000	190 000	6 150	19 400	1 900	3 000	51118	
	135	35	38.5	42	1.1	114 000	310 000	11 600	31 500	1 400	2 200	51218	
	155	50	54.6	59	1.5	214 000	525 000	21 900	53 500	1 100	1 700	51318	
	190	77	81.2	88	2.1	330 000	825 000	33 500	84 000	800	1 200	51418 X	
100	135	25	—	—	1	86 000	268 000	8 750	27 300	1 700	2 600	51120	
	150	38	40.9	45	1.1	135 000	375 000	13 700	38 500	1 300	2 000	51220	
	170	55	59.2	64	1.5	239 000	595 000	24 300	61 000	1 000	1 500	51320	
	210	85	90	98	3	370 000	985 000	38 000	100 000	710	1 100	51420 X	

Note (1) The outside diameter d_1 of the shaft washers of all bearing numbers marked X is smaller than the outside diameter D of the housing washers.

Bearing Numbers ⁽¹⁾		Dimensions (mm)							Abutment and Fillet Dimensions (mm)			Mass (kg) approx		
With Aligning Seat	With Aligning Seat Washer	d_1	D_1	D_2	D_3	b	A	R	d_a min	D_a max	r_a max	With Flat Seat	With Aligning Seat	With Aligning Seat Washer
—	—	78	57	—	—	—	—	—	69	64	0.6	0.227	—	—
53211	53211 U	90	57	72	95	9	35	72	76	69	1	0.599	0.656	0.819
53311	53311 U	105	57	80	110	11.5	30	80	85	75	1	1.31	1.45	1.78
53411	53411 U	120	57	88	125	15.5	28	90	94	81	1.5	2.58	2.59	3.16
—	—	85	62	—	—	—	—	—	75	70	1	0.281	—	—
53212	53212 U	95	62	78	100	9	32.5	72	81	74	1	0.673	0.731	0.897
53312	53312 U	110	62	85	115	11.5	41	90	90	80	1	1.4	1.51	1.83
53412	53412 U	130	62	95	135	16	34	100	102	88	1.5	3.16	3.2	3.91
—	—	90	67	—	—	—	—	—	80	75	1	0.324	—	—
53213	53213 U	100	67	82	105	9	40	80	86	79	1	0.756	0.812	0.989
53313	53313 U	115	67	90	120	12.5	38.5	90	95	85	1	1.54	1.67	2.04
53413	53413 U	140	68	100	145	17.5	40	112	110	95	2	4.1	4.22	5.13
—	—	95	72	—	—	—	—	—	85	80	1	0.346	—	—
53214	53214 U	105	72	88	110	9	38	80	91	84	1	0.793	0.866	1.05
53314	53314 U	125	72	98	130	13	43	100	103	92	1	2.0	2.2	2.64
53414	53414 U	150	73	110	155	19.5	34	112	118	102	2	5.05	5.12	6.21
—	—	100	77	—	—	—	—	—	90	85	1	0.389	—	—
53215	53215 U	110	77	92	115	9.5	49	90	96	89	1	0.845	1.27	1.11
53315	53315 U	135	77	105	140	15	37	100	111	99	1.5	2.6	2.8	3.42
53415	53415 U	160	78	115	165	21	42	125	125	110	2	6.15	6.23	7.58
—	—	105	82	—	—	—	—	—	95	90	1	0.417	—	—
53216	53216 U	115	82	98	120	10	46	90	101	94	1	0.931	1.01	1.23
53316	53316 U	140	82	110	145	15	50	112	116	104	1.5	2.74	2.94	3.55
53416	53416 U	170	83	125	175	22	36	125	133	117	2	7.21	7.33	8.9
—	—	110	87	—	—	—	—	—	100	95	1	0.44	—	—
53217	53217 U	125	88	105	130	11	52	100	109	101	1	1.22	1.35	1.63
53317	53317 U	150	88	115	155	17.5	43	112	124	111	1.5	3.57	3.78	4.67
53417 X	53417 XU	177	88	130	185	23	47	140	141	124	2	8.51	8.72	10.4
—	—	120	92	—	—	—	—	—	108	102	1	0.646	—	—
53218	53218 U	135	93	110	140	13.5	45	100	117	108	1	1.69	1.89	2.38
53318	53318 U	155	93	120	160	18	40	112	129	116	1.5	3.83	4.11	5.09
53418 X	53418 XU	187	93	140	195	25.5	40	140	149	131	2	10.2	10.3	12.4
—	—	135	102	—	—	—	—	—	121	114	1	0.96	—	—
53220	53220 U	150	103	125	155	14	52	112	130	120	1	2.25	2.49	3.03
53320	53320 U	170	103	135	175	18	46	125	142	128	1.5	4.98	5.31	6.37
53420 X	53420 XU	205	103	155	220	27	50	160	165	145	2.5	14.8	15	18.1

SINGLE-DIRECTION THRUST BALL BEARINGS

Bore Diameter 200 – 360 mm

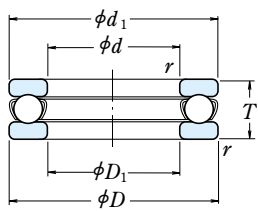

With Flat Seat

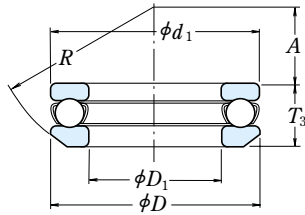

With Aligning Seat

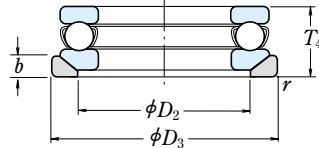

With Aligning Seat Washer

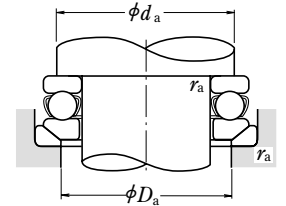
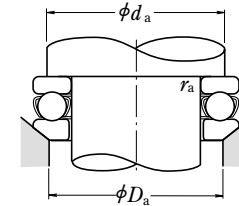
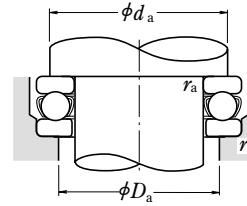

<i>d</i>	Boundary Dimensions (mm)					Basic Load Ratings (N)				Limiting Speeds (min ⁻¹)		With Flat Seat
	<i>D</i>	<i>T</i>	<i>T</i> ₃	<i>T</i> ₄	<i>r</i> _{min}	<i>C</i> _a	<i>C</i> _{0a}	<i>C</i> _a	<i>C</i> _{0a}	Grease	Oil	
200	250	37	—	—	1.1	173 000	675 000	17 600	69 000	1 000	1 500	51140 X
	280	62	65.3	74	2	315 000	1 110 000	32 500	113 000	710	1 100	51240 X
	340	110	118.4	130	4	600 000	2 220 000	61 500	227 000	480	710	51340 X
220	270	37	—	—	1.1	179 000	740 000	18 200	75 500	950	1 500	51144 X
	300	63	65.6	75	2	325 000	1 210 000	33 500	123 000	670	1 000	51244 X
240	300	45	—	—	1.5	229 000	935 000	23 400	95 000	850	1 200	51148 X
	340	78	81.6	92	2.1	420 000	1 650 000	43 000	168 000	560	850	51248 X
260	320	45	—	—	1.5	233 000	990 000	23 800	101 000	800	1 200	51152 X
	360	79	82.8	93	2.1	435 000	1 800 000	44 500	184 000	560	850	51252 X
280	350	53	—	—	1.5	315 000	1 310 000	32 000	134 000	710	1 000	51156 X
	380	80	85	94	2.1	450 000	1 950 000	46 000	199 000	530	800	51256 X
300	380	62	—	—	2	360 000	1 560 000	36 500	159 000	600	900	51160 X
	420	95	100.5	112	3	540 000	2 410 000	55 000	246 000	450	670	51260 X
320	400	63	—	—	2	365 000	1 660 000	37 500	169 000	600	900	51164 X
	440	95	100.5	112	3	585 000	2 680 000	59 500	273 000	450	670	51264 X
340	420	64	—	—	2	375 000	1 760 000	38 500	179 000	560	850	51168 X
	460	96	100.3	113	3	595 000	2 800 000	60 500	285 000	430	630	51268 X
360	440	65	—	—	2	385 000	1 860 000	39 000	190 000	560	800	51172 X
	500	110	116.7	130	4	705 000	3 500 000	72 000	355 000	380	560	51272 X

Note ⁽¹⁾ The outside diameter *d*₁ of the shaft washers of all bearing numbers marked X is smaller than the outside diameter *D* of the housing washers.

Bearing Numbers ⁽¹⁾		Dimensions (mm)							Abutment and Fillet Dimensions (mm)			Mass(kg) approx		
With Aligning Seat	With Aligning Seat Washer	<i>d</i> ₁	<i>D</i> ₁	<i>D</i> ₂	<i>D</i> ₃	<i>b</i>	<i>A</i>	<i>R</i>	<i>d</i> _{a min}	<i>D</i> _{a max}	<i>r</i> _{a max}	With Flat Seat	With Aligning Seat	With Aligning Seat Washer
—	—	247	203	—	—	—	—	—	230	220	1	3.75	—	—
53240 X	53240 XU	277	204	240	290	23	125	225	248	232	2	12.3	13.4	16.1
53340 X	53340 XU	335	205	270	350	38	92	250	282	258	3	43.6	46.2	54.8
—	—	267	223	—	—	—	—	—	250	240	1	4.09	—	—
53244 X	53244 XU	297	224	260	310	25	118	225	268	252	2	13.6	14.9	18
—	—	297	243	—	—	—	—	—	276	264	1.5	6.55	—	—
53248 X	53248 XU	335	244	290	350	30	122	250	299	281	2	23.7	25.6	30.7
—	—	317	263	—	—	—	—	—	296	284	1.5	7.01	—	—
53252 X	53252 XU	355	264	305	370	30	152	280	319	301	2	25.1	27.3	33.2
—	—	347	283	—	—	—	—	—	322	308	1.5	12	—	—
53256 X	53256 XU	375	284	325	390	31	143	280	339	321	2	27.1	30.3	37
—	—	376	304	—	—	—	—	—	348	332	2	17.2	—	—
53260 X	53260 XU	415	304	360	430	34	164	320	371	349	2.5	43.5	47.7	56.1
—	—	396	324	—	—	—	—	—	368	352	2	18.6	—	—
53264 X	53264 XU	435	325	380	450	36	157	320	391	369	2.5	45	49.9	59.4
—	—	416	344	—	—	—	—	—	388	372	2	19.9	—	—
53268 X	53268 XU	455	345	400	470	36	199	360	411	389	2.5	47.9	52.7	62
—	—	436	364	—	—	—	—	—	408	392	2	21.5	—	—
53272 X	53272 XU	495	365	430	510	43	172	360	442	418	3	68.8	76.3	90.9

DOUBLE-DIRECTION THRUST BALL BEARINGS

Bore Diameter 10 – 55 mm

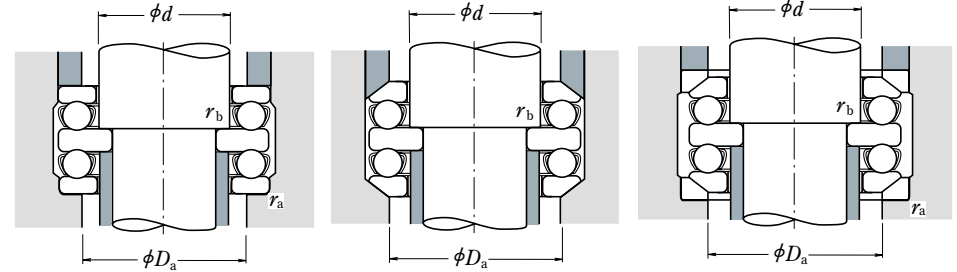
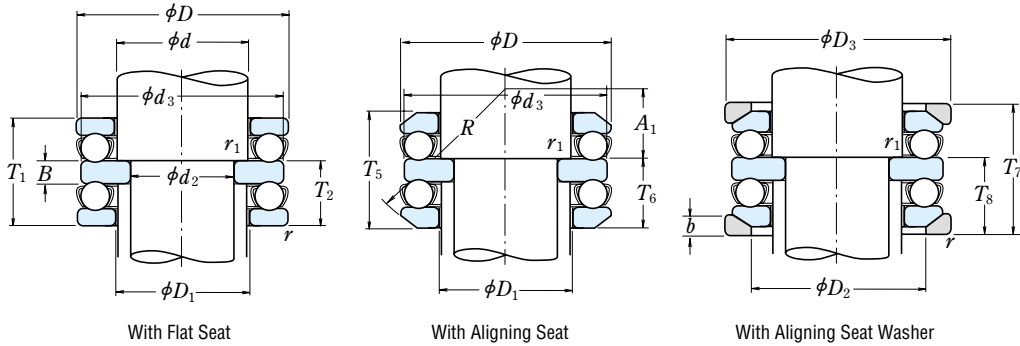

Boundary Dimensions (mm)									Basic Load Ratings (N) (kgf)				Limiting Speeds (min ⁻¹)		Bearing Numbers	
d_2	d	D	T_1	T_5	T_7	r_{\min}	$r_{1\min}$		C_a	C_{0a}	C_a	C_{0a}	Grease	Oil	With Flat Seat	With Aligning Seat
10	15	32	22	24.6	28	0.6	0.3		16 700	24 800	1 710	2 530	4 800	7 100	52202	54202
15	20	40	26	27.4	32	0.6	0.3		22 500	37 500	2 290	3 850	4 000	6 000	52204	54204
	25	60	45	49.8	55	1	0.6		56 000	89 500	5 700	9 100	2 400	3 600	52405	54405
20	25	47	28	31.4	36	0.6	0.3		28 000	50 500	2 860	5 150	3 400	5 300	52205	54205
	25	52	34	37.6	42	1	0.3		36 000	61 500	3 650	6 250	3 000	4 500	52305	54305
	30	70	52	56.2	62	1	0.6		73 000	126 000	7 450	12 800	2 200	3 200	52406	54406
25	30	52	29	32.6	37	0.6	0.3		29 500	58 000	3 000	5 950	3 200	5 000	52206	54206
	30	60	38	41.2	46	1	0.3		43 000	78 500	4 400	8 000	2 600	4 000	52306	54306
	35	80	59	63	69	1.1	0.6		87 500	155 000	8 950	15 800	1 800	2 800	52407	54407
30	35	62	34	37.8	42	1	0.3		39 500	78 000	4 050	7 950	2 800	4 300	52207	54207
	35	68	44	47.2	52	1	0.3		56 000	105 000	5 700	10 700	2 400	3 600	52307	54307
	40	68	36	38.6	44	1	0.6		47 500	98 500	4 850	10 000	2 600	3 800	52208	54208
	40	78	49	54	59	1	0.6		70 000	135 000	7 100	13 700	2 000	3 000	52308	54308
35	40	90	65	69.4	77	1.1	0.6		103 000	188 000	10 500	19 100	1 700	2 400	52408	54408
	45	73	37	39.6	45	1	0.6		48 000	105 000	4 900	10 700	2 400	3 600	52209	54209
	45	85	52	56.2	62	1	0.6		80 500	163 000	8 200	16 700	1 900	2 800	52309	54309
40	45	100	72	78.8	86	1.1	0.6		128 000	246 000	13 000	25 100	1 500	2 200	52409	54409
	50	78	39	42	47	1	0.6		49 000	111 000	5 000	11 400	2 400	3 400	52210	54210
	50	95	58	64.6	70	1.1	0.6		97 500	202 000	9 950	20 600	1 700	2 600	52310	54310
45	50	110	78	83.2	92	1.5	0.6		147 000	288 000	15 000	29 400	1 400	2 000	52410	54410
	55	90	45	49.6	55	1	0.6		70 000	159 000	7 150	16 200	2 000	3 000	52211	54211
	55	105	64	72.6	78	1.1	0.6		115 000	244 000	11 800	24 900	1 500	2 400	52311	54311
50	55	120	87	92	101	1.5	0.6		181 000	350 000	18 500	35 500	1 200	1 800	52411	54411
	60	95	46	50	56	1	0.6		71 500	169 000	7 300	17 200	1 900	3 000	52212	54212
	60	110	64	70.6	78	1.1	0.6		119 000	263 000	12 100	26 800	1 500	2 200	52312	54312
55	60	130	93	99	107	1.5	0.6		202 000	395 000	20 600	40 500	1 100	1 700	52412	54412
	65	140	101	109.4	119	2	1		234 000	495 000	23 800	50 500	1 000	1 600	52413	54413
70	65	100	47	50.4	57	1	0.6		75 500	189 000	7 700	19 200	1 900	2 800	52213	54213
	65	115	65	71.8	79	1.1	0.6		123 000	282 000	12 500	28 200	1 500	2 200	52313	54313
	70	105	47	50.6	57	1	1		74 000	189 000	7 550	19 200	1 800	2 800	52214	54214
	70	125	72	80.4	88	1.1	1		137 000	315 000	14 000	32 000	1 300	2 000	52314	54314
	70	150	107	114.2	125	2	1		252 000	555 000	25 700	56 500	1 000	1 500	52414	54414

With Aligning Seat Washer	Dimensions (mm)											Abutment and Fillet Dimensions (mm)			Mass(kg) approx		
	d_3	D_1	D_2	D_3	T_2	T_6	T_8	B	b	A_1	R	D_a max	r_a max	r_b max	With Flat Seat	With Aligning Seat	With Aligning Seat Washer
54202 U	32	17	24	35	13.5	14.8	16.5	5	4	10.5	28	24	0.6	0.3	0.081	0.090	0.113
54204 U	40	22	30	42	16	16.7	19	6	5	16	36	30	0.6	0.3	0.148	0.151	0.185
54405 U	60	27	42	62	28	30.4	33	11	8	15	50	42	1	0.6	0.641	0.68	0.825
54205 U	47	27	36	50	17.5	19.2	21.5	7	5.5	16.5	40	36	0.6	0.3	0.213	0.236	0.293
54305 U	52	27	38	55	21	22.8	25	8	6	18	45	38	1	0.3	0.324	0.35	0.434
54406 U	70	32	50	75	32	34.1	37	12	9	16	56	50	1	0.6	0.978	1.01	1.27
54206 U	52	32	42	55	18	19.8	22	7	5.5	20	45	42	0.6	0.3	0.254	0.288	0.345
54306 U	60	32	45	62	23.5	25.1	27.5	9	7	19.5	50	45	1	0.3	0.483	0.511	0.621
54407 U	80	37	58	85	36.5	38.5	41.5	14	10	18.5	64	58	1	0.6	1.43	1.47	1.83
54207 U	62	37	48	65	21	22.9	25	8	7	21	50	48	1	0.3	0.406	0.447	0.57
54307 U	68	37	52	72	27	28.6	31	10	7.5	21	56	52	1	0.3	0.71	0.744	0.915
54208 U	68	42	55	72	22.5	23.8	26.5	9	7	25	56	55	1	0.6	0.543	0.581	0.713
54308 U	78	42	60	82	30.5	33	35.5	12	8.5	23.5	64	60	1	0.6	1.04	1.13	1.38
54408 U	90	42	65	95	40	42.2	46	15	12	22	72	65	1	0.6	1.98	2.02	2.54
54209 U	73	47	60	78	23	24.3	27	9	7.5	23	56	60	1	0.6	0.606	0.652	0.823
54309 U	85	47	65	90	32	34.1	37	12	10	21	64	65	1	0.6	1.28	1.34	1.71
54409 U	100	47	72	105	44.5	47.9	51.5	17	12.5	23.5	80	72	1	0.6	2.71	2.85	3.53
54210 U	78	52	62	82	24	25.5	28	9	7.5	30.5	64	62	1	0.6	0.697	0.75	0.949
54310 U	95	52	72	100	36	39.3	42	14	11	23	72	72	1	0.6	1.78	1.94	2.46
54410 U	110	52	80	115	48	50.6	55	18	14	30	90	80	1.5	0.6	3.51	3.59	4.45
54211 U	90	57	72	95	27.5	29.8	32.5	10	9	32.5	72	72	1	0.6	1.11	1.22	1.55
54311 U	105	57	80	110	39.5	43.8	46.5	15	11.5	25.5	80	80	1	0.6	2.43	2.7	3.35
54411 U	120	57	88	125	53.5	56	60.5	20	15.5	22.5	90	88	1.5	0.6	4.66	4.68	5.82
54212 U	95	62	78	100	28	30	33	10	9	30.5	72	78	1	0.6	1.22	1.33	1.66
54312 U	110	62	85	115	39.5	42.8	46.5	15	11.5	36.5	90	85	1	0.6	2.59	2.82	3.45
54412 U	130	62	95	135	57	60	64	21	16	28	100	95	1.5	0.6	5.74	5.82	7.24
54413 U	140	68	100	145	62	66.2	71	23	17.5	34	112	100	2	1	7.41	7.66	9.47
54213 U	100	67	82	105	28.5	30.2	33.5	10	9	38.5	80	82	1	0.6	1.34	1.45	1.81
54313 U	115	67	90	120	40	43.4	47	15	12.5	34.5	90	90	1	0.6	2.8	3.06	3.8
54214 U	105	72	88	110	28.5	30.3	33.5	10	9	36.5	80	88	1	1	1.44	1.59	1.95
54314 U	125	72	98	130	44	48.2	52	16	13	39	100	98	1	1	3.67	4.07	4.95
54414 U	150	73	110	155	65.5	69.1	74.5	24	19.5	28.5	112	110	2	1	8.99	9.12	11.3

DOUBLE-DIRECTION THRUST BALL BEARINGS

Bore Diameter 60 – 130 mm

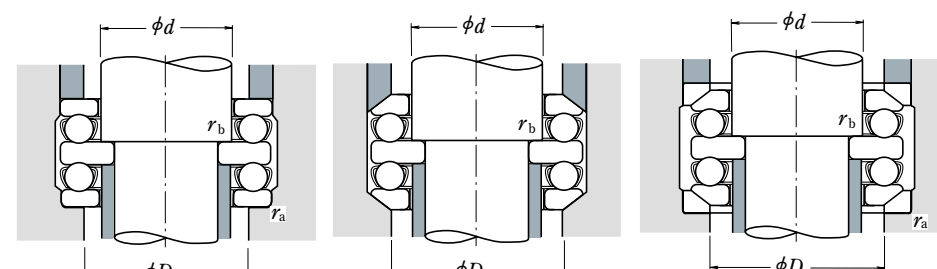
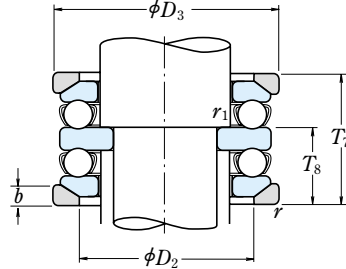
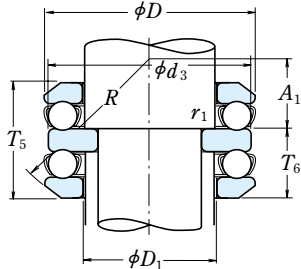
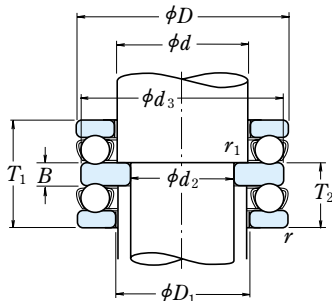

With Flat Seat

With Aligning Seat

With Aligning Seat Washer

Table containing Boundary Dimensions (mm), Basic Load Ratings (N, kgf), Limiting Speeds (min⁻¹), and Bearing Numbers for various bearing sizes (60 to 130 mm).

Table containing Dimensions (mm), Abutment and Fillet Dimensions (mm), and Mass (kg) for various bearing models (52215 U, 54215 U, 54415 U, etc.).

Note (1) The outside diameter d3 of the central washers of all bearing numbers marked X is smaller than the outside diameter D of the housing washers.

DOUBLE-DIRECTION THRUST BALL BEARINGS

Bore Diameter 135 – 190 mm

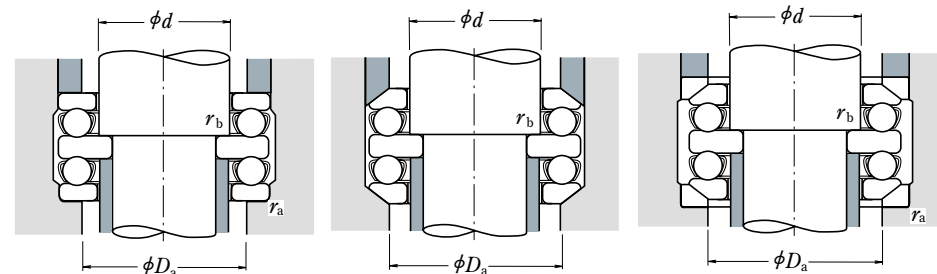
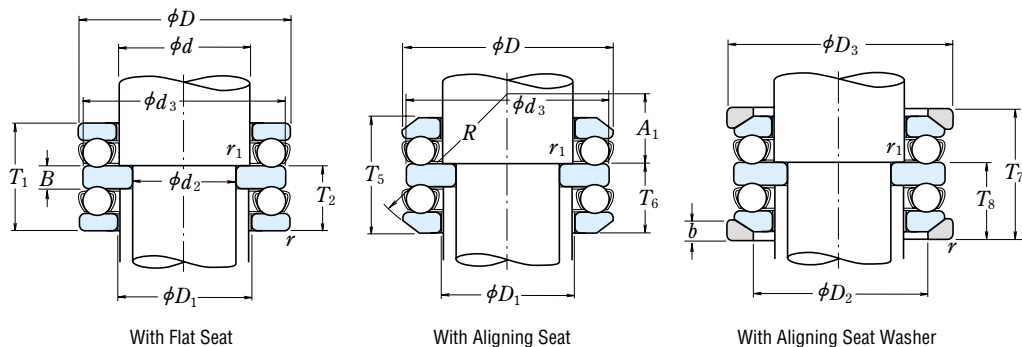

d_2	Boundary Dimensions (mm)							Basic Load Ratings (N) (kgf)				Limiting Speeds (min ⁻¹)		Bearing Numbers ⁽¹⁾	
	d	D	T_1	T_5	T_7	r_{\min}	$r_{1\min}$	C_a	C_{0a}	C_a	C_{0a}	Grease	Oil	With Flat Seat	With Aligning Seat
135	170	340	236	—	—	5	2.1	715 000	2 480 000	73 000	253 000	400	600	52434 X	—
140	160	225	90	97.4	110	1.5	1.1	249 000	805 000	25 400	82 000	850	1 300	52232 X	54232 X
	160	270	153	—	—	3	1.1	475 000	1 570 000	48 500	160 000	600	900	52332 X	—
	180	360	245	—	—	5	3	750 000	2 730 000	76 500	278 000	380	560	52436 X	—
150	170	240	97	104.4	117	1.5	1.1	280 000	915 000	28 500	93 000	800	1 200	52234 X	54234 X
	170	280	153	—	—	3	1.1	465 000	1 570 000	47 500	160 000	560	850	52334 X	—
	180	250	98	102.4	118	1.5	2	284 000	955 000	28 900	97 000	800	1 200	52236 X	54236 X
	180	300	165	—	—	3	3	480 000	1 680 000	49 000	171 000	530	800	52336 X	—
160	190	270	109	116.4	131	2	2	320 000	1 110 000	32 500	113 000	710	1 100	52238 X	54238 X
	190	320	183	—	—	4	2	550 000	1 960 000	56 000	199 000	480	710	52338 X	—
170	200	280	109	115.6	133	2	2	315 000	1 110 000	32 500	113 000	710	1 000	52240 X	54240 X
	200	340	192	—	—	4	2	600 000	2 220 000	61 500	227 000	450	670	52340 X	—
190	220	300	110	115.2	134	2	2	325 000	1 210 000	33 500	123 000	670	1 000	52244 X	54244 X

Note (1) The outside diameter d_3 of the central washers of all bearing numbers marked X is smaller than the outside diameter D of the housing washers.

With Aligning Seat Washer	Dimensions (mm)											Abutment and Fillet Dimensions (mm)			Mass(kg) approx		
	d_3	D_1	D_2	D_3	T_2	T_6	T_8	B	b	A_1	R	$D_{a\max}$	$r_{a\max}$	$r_{b\max}$	With Flat Seat	With Aligning Seat	With Aligning Seat Washer
—	339	174	—	—	143	—	—	50	—	—	—	240	4	2	110	—	—
54232 XU	224.5	163	190	235	55	58.7	65	20	21	70	160	190	1.5	1	11.2	12.7	16.5
	—	269	164	—	93	—	—	33	—	—	—	205	2.5	1	35.1	—	—
	—	359	184	—	148.5	—	—	52	—	—	—	254	4	2.5	126	—	—
54234 XU	239.5	173	200	250	59	62.7	69	21	21.5	87	180	200	1.5	1	13.6	15.2	19.8
	—	279	174	—	93	—	—	33	—	—	—	215	2.5	1	40.8	—	—
54236 XU	249	183	210	260	59.5	61.7	69.5	21	21.5	108.5	200	210	1.5	2	14.8	16.1	20.6
	—	299	184	—	101	—	—	37	—	—	—	229	2.5	2.5	46.3	—	—
54238 XU	269	194	230	280	66.5	70.2	77.5	24	23	93.5	200	230	2	2	22.1	22.2	29.8
	—	319	195	—	111.5	—	—	40	—	—	—	244	3	2	113	—	—
54240 XU	279	204	240	290	66.5	69.8	78.5	24	23	120.5	225	240	2	2	23.1	23.2	30.6
	—	339	205	—	117	—	—	42	—	—	—	258	3	2	78.4	—	—
54244 XU	299	224	260	310	67	69.6	79	24	25	114	225	260	2	2	25.2	27.8	34.1

Bore Diameter 35 – 130 mm

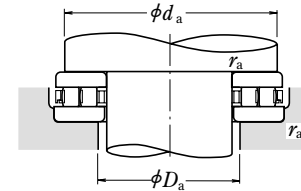
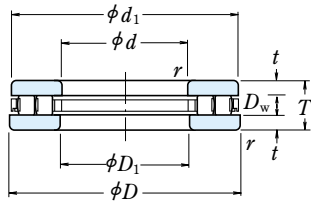

Boundary Dimensions (mm)				Basic Load Ratings (N)		Limiting Speeds (min ⁻¹)	
<i>d</i>	<i>D</i>	<i>T</i>	<i>r</i> _{min}	<i>C_a</i>	<i>C_{0a}</i>	Grease	Oil
35	80	32	1.1	95 000	247 000	1 000	3 000
40	78	22	1	63 000	194 000	1 200	3 600
45	65	14	0.6	33 000	100 000	1 700	5 000
	85	24	1	71 000	233 000	1 100	3 400
50	110	27	1.1	139 000	470 000	900	2 800
	95	27	1.1	113 000	350 000	1 000	3 000
55	105	30	1.1	134 000	450 000	900	2 600
60	95	26	1	99 000	325 000	1 000	3 000
	110	30	1.1	139 000	480 000	850	2 600
65	100	27	1	110 000	325 000	950	2 800
	115	30	1.1	145 000	515 000	850	2 600
70	150	36	2	259 000	935 000	670	2 000
	125	34	1.1	191 000	635 000	750	2 200
75	100	19	1	63 500	221 000	1 100	3 400
	135	36	1.5	209 000	735 000	710	2 200
80	115	28	1	120 000	420 000	900	2 600
	140	36	1.5	208 000	740 000	710	2 000
85	110	19	1	75 000	298 000	1 100	3 200
	125	31	1	151 000	485 000	800	2 400
	150	39	1.5	257 000	995 000	630	1 900
90	120	22	1	96 000	370 000	950	3 000
	155	39	1.5	250 000	885 000	630	1 900
100	170	42	1.5	292 000	1 110 000	560	1 700
110	160	38	1.1	228 000	855 000	630	1 900
	190	48	2	390 000	1 490 000	500	1 500
120	170	39	1.1	233 000	895 000	600	1 800
	210	54	2.1	505 000	1 930 000	450	1 400
130	190	45	1.5	300 000	1 090 000	530	1 600
	225	58	2.1	585 000	2 370 000	430	1 300
	270	85	4	895 000	3 300 000	320	950

Bearing Numbers	Dimensions (mm)				Abutment and Fillet Dimensions (mm)			Mass (kg) approx
	<i>d</i> ₁	<i>D</i> ₁	<i>D</i> _w	<i>t</i>	<i>d</i> _{a min}	<i>D</i> _{a max}	<i>r</i> _{a max}	
35 TMP 14	80	37	12	10	71	46	1	0.97
40 TMP 93	78	42	8	7	71	48	1	0.525
45 TMP 11	65	47	6	4	60	49	0.6	0.144
45 TMP 93	85	47	8	8	78	53	1	0.665
50 TMP 74	109	52	11	8	100	61	1	1.52
50 TMP 93	93	52	11	8	89	57	1	0.94
55 TMP 93	105	55.2	11	9.5	98	63	1	1.28
60 TMP 12	95	62	10	8	88	67	1	0.735
60 TMP 93	110	62	11	9.5	103	68	1	1.36
65 TMP 12	100	67	12.5	7.25	93	71	1	0.805
65 TMP 93	115	65.2	11	9.5	108	73	1	1.44
70 TMP 74	149	72	15	10.5	137	84	2	3.8
70 TMP 93	125	72	14	10	117	78	1	1.95
75 TMP 11	100	77	8	5.5	96	79	1	0.41
75 TMP 93	135	77	14	11	125	84	1.5	2.42
80 TMP 12	115	82	11	8.5	109	86	1	1.02
80 TMP 93	138	82	14	11	130	91	1.5	2.54
85 TMP 11	110	87	7.5	5.75	105	89	1	0.46
85 TMP 12	125	88	14	8.5	118	92	1	1.36
85 TMP 93	148	87	14	12.5	140	95	1.5	3.2
90 TMP 11	119	91.5	9	6.5	114	95	1	0.725
90 TMP 93	155	90.2	16	11.5	144	101	1.5	3.3
100 TMP 93	170	103	16	13	159	110	1.5	4.25
110 TMP 12	160	113	15	11.5	150	119	1	2.66
110 TMP 93	190	113	19	14.5	179	120	2	6.15
120 TMP 12	170	123	15	12	160	129	1	2.93
120 TMP 93	210	123	22	16	199	129	2	8.55
130 TMP 12	187	133	19	13	177	142	1.5	4.5
130 TMP 93	225	133	22	18	214	140	2	10.4
130 TMP 94	270	133	32	26.5	254	150	3	26.2

Remarks For cylindrical roller thrust bearings not listed above, please contact NSK.

Bore Diameter 140 – 320 mm

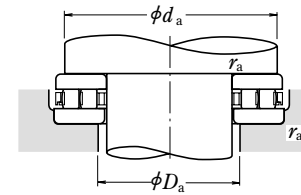
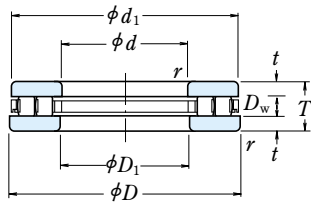

<i>d</i>	Boundary Dimensions (mm)			Basic Load Ratings (N)		Limiting Speeds (min ⁻¹)	
	<i>D</i>	<i>T</i>	<i>r</i> _{min}	<i>C</i> _a	<i>C</i> _{0a}	Grease	Oil
140	200	46	2	285 000	1 120 000	500	1 500
	240	60	2.1	610 000	2 360 000	400	1 200
	280	85	4	990 000	3 800 000	300	900
150	215	50	2	375 000	1 500 000	480	1 400
	250	60	2.1	635 000	2 510 000	400	1 200
160	200	31	1	173 000	815 000	630	1 900
	270	67	3	745 000	3 150 000	360	1 100
170	240	55	1.5	485 000	1 960 000	430	1 300
	280	67	3	800 000	3 500 000	340	1 000
180	300	73	3	1 000 000	4 000 000	320	950
	360	109	5	1 640 000	6 200 000	240	710
190	270	62	3	705 000	2 630 000	360	1 100
	320	78	4	1 080 000	4 500 000	300	900
200	250	37	1.1	365 000	1 690 000	500	1 500
	340	85	4	1 180 000	5 150 000	280	800
220	270	37	1.1	385 000	1 860 000	480	1 500
	300	63	2	770 000	3 100 000	340	1 000
240	300	45	1.5	435 000	2 160 000	400	1 200
	340	78	2.1	965 000	4 100 000	280	850
260	320	45	1.5	460 000	2 350 000	400	1 200
	360	79	2.1	995 000	4 350 000	280	850
280	350	53	1.5	545 000	2 800 000	340	1 000
	380	80	2.1	1 050 000	4 750 000	260	800
300	380	62	2	795 000	4 000 000	300	900
	420	95	3	1 390 000	6 250 000	220	670
320	400	63	2	820 000	4 250 000	300	900
	440	95	3	1 420 000	6 550 000	220	670

Bearing Numbers	Dimensions (mm)				Abutment and Fillet Dimensions (mm)			Mass (kg) approx
	<i>d</i> ₁	<i>D</i> ₁	<i>D</i> _w	<i>t</i>	<i>d</i> _{a min}	<i>D</i> _{a max}	<i>r</i> _{a max}	
140 TMP 12	197	143	17	14.5	188	153	2	4.85
140 TMP 93	240	143	25	17.5	226	154	2	12.2
140 TMP 94	280	143	32	26.5	262	158	3	27.5
150 TMP 12	215	153	19	15.5	202	163	2	6.15
150 TMP 93	250	153	25	17.5	236	165	2	12.8
160 TMP 11	200	162	11	10	191	168	1	2.21
160 TMP 93	265	164	25	21	255	173	2.5	16.9
170 TMP 12	237	173	22	16.5	227	182	1.5	8.2
170 TMP 93	280	173	25	21	265	183	2.5	17.7
180 TMP 93	300	185	32	20.5	284	194	2.5	22.5
180 TMP 94	354	189	45	32	335	205	4	58.2
190 TMP 12	266	195	30	16	255	200	2.5	11.8
190 TMP 93	320	195	32	23	303	205	3	27.6
200 TMP 11	247	203	17	10	242	207	1	4.1
200 TMP 93	340	205	32	26.5	322	218	3	34.5
220 TMP 11	267	223	17	10	262	227	1	4.5
220 TMP 12	297	224	30	16.5	287	232	2	13.5
240 TMP 11	297	243	18	13.5	288	251	1.5	7.2
240 TMP 12	335	244	32	23	322	258	2	23.3
260 TMP 11	317	263	18	13.5	308	272	1.5	7.75
260 TMP 12	355	264	32	23.5	342	276	2	25.2
280 TMP 11	347	283	20	16.5	335	294	1.5	11.6
280 TMP 12	375	284	32	24	362	296	2	27.2
300 TMP 11	376	304	25	18.5	365	315	2	16.7
300 TMP 12	415	304	38	28.5	398	322	2.5	42
320 TMP 11	396	324	25	19	385	335	2	18
320 TMP 12	435	325	38	28.5	418	340	2.5	44.5

Remarks For cylindrical roller thrust bearings not listed above, please contact NSK.

SPHERICAL THRUST ROLLER BEARINGS

Bore Diameter 60 – 200 mm

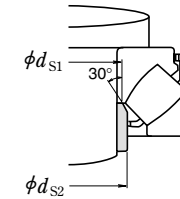
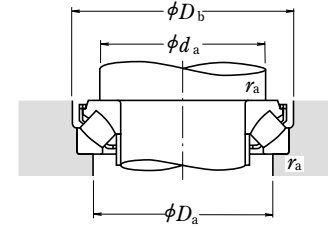
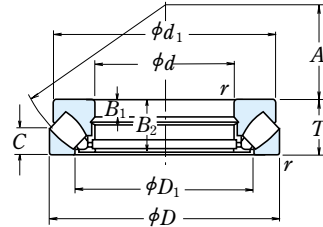
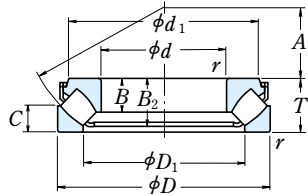

Dynamic Equivalent Load

$$P = 1.2F_r + F_a$$

Static Equivalent Load

$$P_0 = 2.8F_r + F_a$$

However, $F_r/F_a \leq 0.55$ must be satisfied.

Boundary Dimensions (mm)				Basic Load Ratings				Limiting Speeds (min ⁻¹) Oil	Bearing Numbers
d	D	T	r _{min}	C _a (N)	C _{0a} (N)	C _a (kgf)	C _{0a} (kgf)		
60	130	42	1.5	330 000	885 000	33 500	90 000	2 600	29412 E
65	140	45	2	405 000	1 100 000	41 500	112 000	2 400	29413 E
70	150	48	2	450 000	1 240 000	46 000	126 000	2 400	29414 E
75	160	51	2	515 000	1 430 000	52 500	146 000	2 200	29415 E
80	170	54	2.1	575 000	1 600 000	58 500	163 000	2 000	29416 E
85	150	39	1.5	330 000	1 040 000	34 000	106 000	2 400	29317 E
	180	58	2.1	630 000	1 760 000	64 500	179 000	1 900	29417 E
90	155	39	1.5	350 000	1 080 000	35 500	110 000	2 200	29318 E
	190	60	2.1	695 000	1 950 000	70 500	199 000	1 800	29418 E
100	170	42	1.5	410 000	1 280 000	41 500	131 000	2 000	29320 E
	210	67	3	840 000	2 400 000	86 000	245 000	1 600	29420 E
110	190	48	2	530 000	1 710 000	54 000	174 000	1 800	29322 E
	230	73	3	1 010 000	2 930 000	103 000	299 000	1 500	29422 E
120	210	54	2.1	645 000	2 100 000	65 500	214 000	1 600	29324 E
	250	78	4	1 160 000	3 400 000	119 000	350 000	1 400	29424 E
130	225	58	2.1	740 000	2 450 000	75 500	250 000	1 500	29326 E
	270	85	4	1 330 000	3 900 000	135 000	400 000	1 200	29426 E
140	240	60	2.1	840 000	2 810 000	85 500	287 000	1 400	29328 E
	280	85	4	1 370 000	4 200 000	140 000	425 000	1 200	29428 E
150	250	60	2.1	870 000	2 900 000	89 000	296 000	1 400	29330 E
	300	90	4	1 580 000	4 900 000	162 000	500 000	1 100	29430 E
160	270	67	3	1 010 000	3 400 000	103 000	345 000	1 300	29332 E
	320	95	5	1 740 000	5 400 000	178 000	550 000	1 100	29432 E
170	280	67	3	1 050 000	3 500 000	107 000	355 000	1 200	29334 E
	340	103	5	1 680 000	5 800 000	171 000	595 000	1 000	29434 E
180	300	73	3	1 230 000	4 200 000	125 000	430 000	1 100	29336 E
	360	109	5	1 870 000	6 500 000	190 000	660 000	900	29436 E
190	320	78	4	1 370 000	4 700 000	140 000	480 000	1 100	29338 E
	380	115	5	2 100 000	7 450 000	215 000	760 000	850	29438 E
200	280	48	2	540 000	2 310 000	55 000	236 000	1 500	29240
	340	85	4	1 570 000	5 450 000	160 000	555 000	1 000	29340 E
	400	122	5	2 290 000	8 150 000	234 000	835 000	800	29440

Dimensions (mm)						Spacer Sleeve Dimensions (mm)		Abutment and Fillet Dimensions (mm)				Mass (kg) approx
d ₁	D ₁	B, B ₁	B ₂	C	A	d _{s1} max	d _{s2} max	d _a ⁽¹⁾ min	D _a max	D _b min	r _a max	
114.5	89	27	38	20	38	67	67	90	108	133	1.5	2.55
121.5	93	29.5	40.5	22	42	72	72	100	115	143	2	3.2
131.5	102	31	43	24	44	78	78	105	125	153	2	3.9
138	107	33.5	46	25	47	83	83	115	132	163	2	4.65
148	114.5	35	48.5	27	50	89	89	120	140	173	2	5.55
134.5	112	24.5	35.5	19	50	91	91	115	135	153	1.5	2.7
156.5	124	37	51.5	28	54	95	95	130	150	183	2	6.55
139.5	118	24.5	35	19	52	97	97	120	140	158	1.5	2.83
165.5	129.5	39	54.5	29	56	100	100	135	157	193	2	7.55
152	128	26.2	38	20.8	58	107	107	130	150	173	1.5	3.6
185	144	43	59.5	33	62	111	111	150	175	214	2.5	10.3
169.5	142.5	30.3	43.5	24	64	117	117	145	165	193	2	5.25
200	157	47	64.5	36	69	121	129	165	190	234	2.5	13.3
187.5	156.5	34	48.5	27	70	130	130	160	180	214	2	7.3
215	171	50.5	69.5	38	74	132	142	180	205	254	3	16.6
203.5	168.5	37	53.5	28	76	141	143	170	195	229	2	8.95
235	185	54	74.5	42	81	143	153	195	225	275	3	21.1
216.5	179	38.5	54	30	82	148	154	185	205	244	2	10.4
244.5	195.5	54	74.5	42	86	153	162	205	235	285	3	22.2
224	190	38	54.5	29	87	158	163	195	215	254	2	10.8
266	209	58	81	44	92	164	175	220	250	306	3	27.3
243	203	42	60	33	92	169	176	210	235	275	2.5	14.3
278	224.5	60.5	84.5	46	99	175	189	230	265	326	4	32.1
252	214.5	42.2	60.5	32	96	178	188	220	245	285	2.5	14.8
310	243	37	99	50	104	—	—	245	285	—	4	43.5
270	227	46	65.5	36	103	189	195	235	260	306	2.5	19
330	255	39	105	52	110	—	—	260	300	—	4	52
288.5	244	49	69	38	110	200	211	250	275	326	3	23
345	271	41	111	55	117	—	—	275	320	—	4	60
266	236	15	46	24	108	—	—	235	255	—	2	8.55
306.5	257	53.5	75	41	116	211	224	265	295	346	3	28.5
365	280	43	117	59	122	—	—	290	335	—	4	69

Note (1) For heavy load applications, a d_a value should be chosen which is large enough to support the shaft washer rib.

Bore Diameter 220 – 420 mm

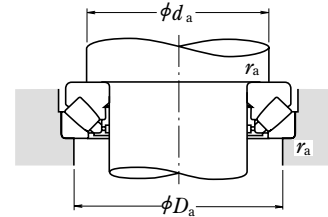
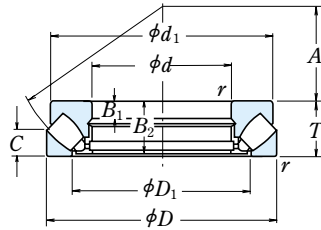

Dynamic Equivalent Load
 $P = 1.2F_r + F_a$
Static Equivalent Load
 $P_0 = 2.8F_r + F_a$
 However, $F_r/F_a \leq 0.55$ must be satisfied.

Boundary Dimensions (mm)				Basic Load Ratings				Limiting Speeds (min ⁻¹) Oil	Bearing Numbers
<i>d</i>	<i>D</i>	<i>T</i>	<i>r</i> _{min}	(N)		{kgf}			
				<i>C_a</i>	<i>C_{0a}</i>	<i>C_a</i>	<i>C_{0a}</i>		
220	300	48	2	560 000	2 500 000	57 000	255 000	1 400	29244
	360	85	4	1 340 000	5 200 000	137 000	530 000	950	29344
	420	122	6	2 350 000	8 650 000	240 000	880 000	800	29444
240	340	60	2.1	800 000	3 450 000	82 000	350 000	1 200	29248
	380	85	4	1 360 000	5 400 000	139 000	550 000	950	29348
	440	122	6	2 420 000	9 100 000	247 000	930 000	750	29448
260	360	60	2.1	855 000	3 850 000	87 500	395 000	1 200	29252
	420	95	5	1 700 000	6 800 000	173 000	695 000	800	29352
	480	132	6	2 820 000	10 700 000	287 000	1 090 000	710	29452
280	380	60	2.1	885 000	4 100 000	90 000	420 000	1 100	29256
	440	95	5	1 830 000	7 650 000	187 000	780 000	800	29356
	520	145	6	3 400 000	13 100 000	345 000	1 330 000	630	29456
300	420	73	3	1 160 000	5 150 000	118 000	525 000	950	29260
	480	109	5	2 190 000	9 100 000	224 000	925 000	710	29360
	540	145	6	3 500 000	13 700 000	355 000	1 390 000	630	29460
320	440	73	3	1 190 000	5 450 000	122 000	555 000	950	29264
	500	109	5	2 230 000	9 400 000	227 000	960 000	670	29364
	580	155	7.5	3 650 000	14 600 000	370 000	1 490 000	560	29464
340	460	73	3	1 230 000	5 750 000	125 000	590 000	900	29268
	540	122	5	2 640 000	11 200 000	269 000	1 140 000	630	29368
	620	170	7.5	4 400 000	17 400 000	450 000	1 780 000	530	29468
360	500	85	4	1 550 000	7 300 000	158 000	745 000	800	29272
	560	122	5	2 670 000	11 500 000	272 000	1 180 000	600	29372
	640	170	7.5	4 200 000	17 200 000	430 000	1 750 000	500	29472
380	520	85	4	1 620 000	7 800 000	165 000	795 000	800	29276
	600	132	6	3 300 000	14 500 000	335 000	1 480 000	560	29376
	670	175	7.5	4 800 000	19 500 000	490 000	1 990 000	480	29476
400	540	85	4	1 640 000	8 000 000	167 000	815 000	750	29280
	620	132	6	3 250 000	14 500 000	330 000	1 480 000	530	29380
	710	185	7.5	5 400 000	22 100 000	550 000	2 250 000	450	29480
420	580	95	5	2 010 000	9 800 000	205 000	1 000 000	670	29284
	650	140	6	3 500 000	15 700 000	355 000	1 600 000	500	29384
	730	185	7.5	5 650 000	23 500 000	575 000	2 400 000	450	29484

Dimensions (mm)						Abutment and Fillet Dimensions (mm)			Mass (kg) approx
<i>d</i> ₁	<i>D</i> ₁	<i>B</i> ₁	<i>B</i> ₂	<i>C</i>	<i>A</i>	<i>d</i> _a ⁽¹⁾ min	<i>D</i> _a max	<i>r</i> _a max	
285	254	15	46	24	117	260	275	2	9.2
335	280	29	81	41	125	285	315	3	33
385	308	43	117	58	132	310	355	5	74
325	283	19	57	30	130	285	305	2	16.5
355	300	29	81	41	135	300	330	3	35.5
405	326	43	117	59	142	330	375	5	79
345	302	19	57	30	139	305	325	2	18
390	329	32	91	45	148	330	365	4	48.5
445	357	48	127	64	154	360	405	5	105
365	323	19	57	30	150	325	345	2	19
410	348	32	91	46	158	350	390	4	52.5
480	384	52	140	68	166	390	440	5	132
400	353	21	69	38	162	355	380	2.5	30
450	379	37	105	50	168	380	420	4	74
500	402	52	140	70	175	410	460	5	140
420	372	21	69	38	172	375	400	2.5	32.5
470	399	37	105	53	180	400	440	4	77
555	436	55	149	75	191	435	495	6	175
440	395	21	69	37	183	395	420	2.5	33.5
510	428	41	117	59	192	430	470	4	103
590	462	61	164	82	201	465	530	6	218
480	423	25	81	44	194	420	455	3	51
525	448	41	117	59	202	450	495	4	107
610	480	61	164	82	210	485	550	6	228
496	441	27	81	42	202	440	475	3	52
568	477	44	127	63	216	480	525	5	140
640	504	63	168	85	230	510	575	6	254
517	460	27	81	42	212	460	490	3	55
590	494	44	127	64	225	500	550	5	150
680	536	67	178	89	236	540	610	6	306
553	489	30	91	46	225	490	525	4	72
620	520	48	135	68	235	525	575	5	170
700	556	67	178	89	244	560	630	6	323

Note (1) For heavy load applications, a *d_a* value should be chosen which is large enough to support the shaft washer rib.

Bore Diameter 440 – 500 mm

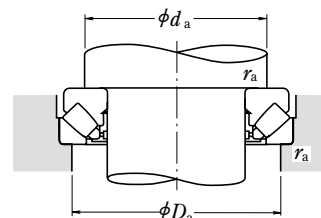
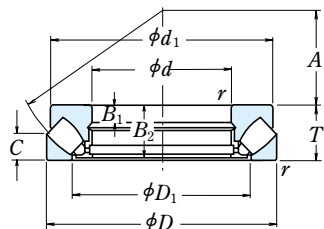

Dynamic Equivalent Load

$$P = 1.2F_r + F_a$$

Static Equivalent Load

$$P_0 = 2.8F_r + F_a$$

However, $F_r/F_a \leq 0.55$ must be satisfied.

Boundary Dimensions (mm)				Basic Load Ratings (N) (kgf)				Limiting Speeds (min ⁻¹) Oil	Bearing Numbers
d	D	T	r _{min}	C _a	C _{0a}	C _a	C _{0a}		
440	600	95	5	2 030 000	10 100 000	207 000	1 030 000	670	29288
	680	145	6	3 750 000	16 700 000	380 000	1 710 000	480	29388
	780	206	9.5	6 550 000	27 200 000	665 000	2 770 000	400	29488
460	620	95	5	2 060 000	10 300 000	210 000	1 050 000	670	29292
	710	150	6	4 100 000	18 400 000	420 000	1 880 000	450	29392
	800	206	9.5	6 750 000	28 600 000	690 000	2 920 000	380	29492
480	650	103	5	2 370 000	12 100 000	241 000	1 240 000	600	29296
	730	150	6	4 150 000	19 000 000	425 000	1 940 000	450	29396
	850	224	9.5	7 200 000	31 000 000	730 000	3 150 000	360	29496
500	670	103	5	2 390 000	12 400 000	244 000	1 270 000	600	292/500
	750	150	6	4 350 000	20 400 000	445 000	2 080 000	450	293/500
	870	224	9.5	7 850 000	33 000 000	800 000	3 350 000	340	294/500

Dimensions (mm)						Abutment and Fillet Dimensions (mm)			Mass (kg) approx
d ₁	D ₁	B ₁	B ₂	C	A	d _a ⁽¹⁾ _{min}	D _a _{max}	r _a _{max}	
575	508	30	91	49	235	510	545	4	77
645	548	49	140	70	245	550	600	5	190
745	588	74	199	100	260	595	670	8	407
592	530	30	91	46	245	530	570	4	80
666	567	51	144	72	257	575	630	5	210
765	608	74	199	100	272	615	690	8	420
624	556	33	99	55	259	555	595	4	97
690	590	51	144	72	270	595	650	5	215
810	638	81	216	108	280	645	730	8	545
645	574	33	99	55	268	575	615	4	100
715	611	51	144	74	280	615	670	5	220
830	661	81	216	107	290	670	750	8	560

Note (1) For heavy load applications, a d_a value should be chosen which is large enough to support the shaft washer rib.

ANGULAR CONTACT THRUST BALL BEARINGS

DOUBLE-DIRECTION ANGULAR CONTACT THRUST BALL BEARINGS	Bore Diameter 35 – 280mm.....	B234
ANGULAR CONTACT THRUST BALL BEARINGS FOR BALL SCREWS	Bore Diameter 15 – 60mm.....	B238

DESIGN, TYPE, AND FEATURES

DOUBLE-DIRECTION ANGULAR CONTACT THRUST BALL BEARINGS

Double-Direction Angular Contact Thrust Ball Bearings are specially designed high precision bearings for the main spindles of machine tools.

Compared with the Thrust Ball Bearings in the 511 Series, this type contains more balls of smaller diameter and has a contact angle of 60°. Consequently, the influence of centrifugal force is less and they can withstand higher speed and have higher rigidity.

Bearings in Series 20 and 29 have the same inner and outer diameters as the double-row cylindrical roller bearings in Series NN30 and NN49 respectively, and they are both used for high axial loads.

Their cages are machined brass.

There are the BTR, BAR Series of highly rigid angular contact ball bearings suitable for high speed that can be easily replaced by these double-direction angular contact ball bearings. For more details, please contact NSK.

ANGULAR CONTACT THRUST BALL BEARINGS FOR BALL SCREWS

Bearings of this type were specially designed to support NSK Precision Ball Screws. They are usually used in combinations of more than two bearings and with a preload. Their contact angle is 60°. For more details, please refer to Catalog **CAT. No. E1254 SUPER PRECISION BEARINGS**.

Their cages are molded polyamide.

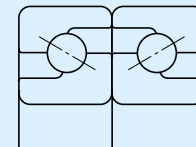
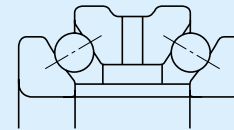

TOLERANCES AND RUNNING ACCURACY

DOUBLE-DIRECTION ANGULAR CONTACT THRUST BALL BEARINGSTable 1

ANGULAR CONTACT THRUST BALL BEARINGS FOR BALL SCREWSTable 2

The limiting chamfer dimensions of bearings of both types conform to Table 8.9.1 (Page A78).

Table 1 Tolerances for Double-Direction Angular Contact Thrust Ball Bearings (Class 7 (1))

Table 1.1 Tolerances for Bearing Bore and Height and Running Accuracy Units : μm

Nominal Bore Diameter d (mm)		Δd_{mp}		ΔT_s		K_{ia} (or K_{ea})	S_d	S_{ia} (or S_{ea})
over	incl	high	low	high	low	max	max	max
—	30	0	-5	0	-300	5	4	3
30	50	0	-5	0	-400	5	4	3
50	80	0	-8	0	-500	6	5	5
80	120	0	-8	0	-600	6	5	5
120	180	0	-10	0	-700	8	8	5
180	250	0	-13	0	-800	8	8	6
250	315	0	-15	0	-900	10	10	6
315	400	0	-18	0	-1200	10	12	7

Note (1) Class 7 is NSK Standard.

Table 1.2 Tolerances for Housing Washer Outside Diameter Units : μm

Nominal Outside Diameter D (mm)		ΔD_s	
over	incl	high	low
30	50	-25	-41
50	80	-30	-49
80	120	-36	-58
120	180	-43	-68
180	250	-50	-79
250	315	-56	-88
315	400	-62	-98
400	500	-68	-108
500	630	-76	-120

Symbols in the tables are described on Page A59.

Table 2 Tolerances and Running Accuracy of Angular Contact Thrust Ball Bearings for Ball Screws (Class 7A (1))

Table 2.1 Tolerances and Limits for Shaft and Housing Washer Units : μm

Nominal Bore Diameter d (mm)		Δd_{mp}		ΔB_s (or ΔC_s)		V_{B_s} (or V_{C_s})	K_{ia}	S_d	S_{ia}
over	incl	high	low	high	low	max	max	max	max
10	18	0	-4	0	-120	1.5	2.5	4	2.5
18	30	0	-5	0	-120	1.5	3	4	2.5
30	50	0	-6	0	-120	1.5	4	4	2.5
50	80	0	-7	0	-150	1.5	4	5	2.5

Note (1) Class 7A is NSK Standard.

RECOMMENDED FITS

DOUBLE-DIRECTION ANGULAR CONTACT THRUST BALL BEARINGS

The shaft washer and shaft should be in soft contact with neither interference nor clearance, and the housing washer and housing bore should be loosely fitted. For a bearing arrangement with a double-row cylindrical roller bearing, the tolerances for the outside diameter should be f6 to produce a loose fit.

ANGULAR CONTACT THRUST BALL BEARINGS FOR BALL SCREWS

A tolerance of h5 is recommended for shafts and H6 for housing bores.

INTERNAL CLEARANCE AND PRELOAD

In order to produce an appropriate preload on bearings when they are mounted, the following axial internal clearances are recommended.

DOUBLE-ROW ANGULAR CONTACT THRUST BALL BEARINGSClearance C7

ANGULAR CONTACT THRUST BALL BEARINGS FOR BALL SCREWSClearance C10

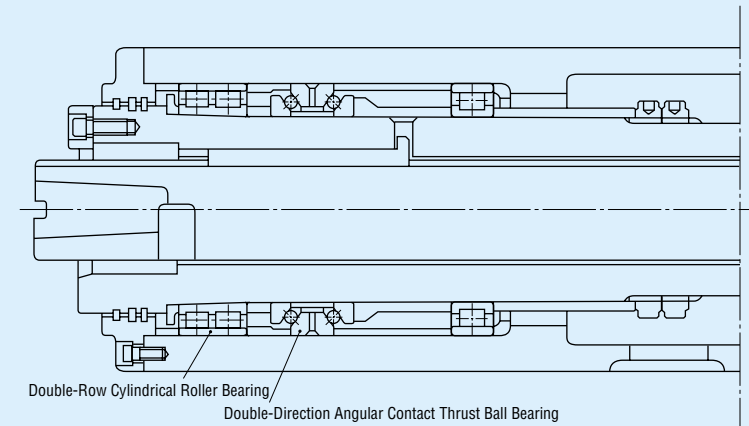

Example of Application of Double-Direction Angular Contact Thrust Ball Bearing (Main Spindle of Machine Tool)

Table 2.2 Tolerances and Running Accuracy of Housing Washer Units : μm

Nominal Outside Diameter D (mm)		ΔD_s		K_{ea}	S_{ea}
over	incl	high	low	max	max
30	50	0	-6	5	2.5
50	80	0	-7	5	2.5
80	120	0	-8	5	2.5

Bore Diameter 35 – 150 mm

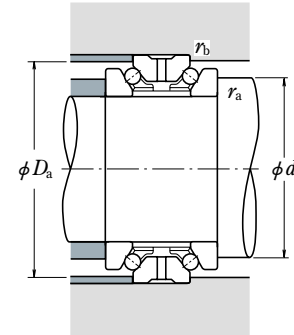
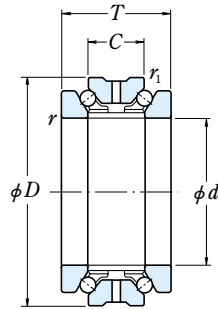

Boundary Dimensions (mm)						Basic Load Ratings				Limiting Speeds	
<i>d</i>	<i>D</i> ⁽¹⁾	<i>T</i>	<i>C</i>	<i>r</i> _{min}	<i>r</i> _{1 min}	(N)		{kgf}		(min ⁻¹)	
						<i>C</i> _a	<i>C</i> _{0a}	<i>C</i> _a	<i>C</i> _{0a}	Grease	Oil
35	62	34	17	1	0.6	22 800	53 500	2 330	5 450	10 000	11 000
40	68	36	18	1	0.6	23 600	59 000	2 410	6 050	9 000	10 000
45	75	38	19	1	0.6	26 300	67 500	2 680	6 900	8 000	9 000
50	80	38	19	1	0.6	27 200	74 000	2 780	7 550	7 000	8 000
55	90	44	22	1.1	0.6	33 500	94 000	3 450	9 550	6 300	6 900
60	95	44	22	1.1	0.6	35 000	102 000	3 550	10 400	5 900	6 500
65	100	44	22	1.1	0.6	36 000	110 000	3 700	11 300	5 500	6 100
70	110	48	24	1.1	0.6	49 500	146 000	5 050	14 900	5 000	5 600
75	115	48	24	1.1	0.6	50 000	152 000	5 100	15 500	4 800	5 300
80	125	54	27	1.1	0.6	59 000	181 000	6 000	18 500	4 400	4 900
85	130	54	27	1.1	0.6	59 500	189 000	6 050	19 300	4 200	4 700
90	140	60	30	1.5	1	78 500	246 000	8 000	25 100	4 000	4 400
95	145	60	30	1.5	1	79 500	256 000	8 100	26 100	3 800	4 200
100	140	48	24	1.1	0.6	55 000	196 000	5 600	20 000	3 800	4 200
	150	60	30	1.5	1	80 500	267 000	8 200	27 200	3 600	4 000
105	145	48	24	1.1	0.6	56 500	208 000	5 750	21 300	3 600	4 000
	160	66	33	2	1	91 500	305 000	9 350	31 000	3 400	3 800
110	150	48	24	1.1	0.6	57 000	215 000	5 800	21 900	3 500	3 900
	170	72	36	2	1	103 000	350 000	10 500	35 500	3 300	3 600
120	165	54	27	1.1	0.6	66 500	256 000	6 800	26 100	3 200	3 600
	180	72	36	2	1	106 000	375 000	10 800	38 000	3 000	3 400
130	180	60	30	1.5	1	79 500	315 000	8 100	32 500	3 000	3 300
	200	84	42	2	1	134 000	455 000	13 600	46 500	2 800	3 100
140	190	60	30	1.5	1	91 500	365 000	9 350	37 500	2 800	3 100
	210	84	42	2	1	145 000	525 000	14 800	53 500	2 600	2 900
150	210	72	36	2	1	116 000	465 000	11 800	47 500	2 500	2 800
	225	90	45	2.1	1.1	172 000	620 000	17 500	63 500	2 400	2 700

Note (1) Outside tolerance is f6.

Bearing Numbers	Abutment and Fillet Dimensions (mm)				Mass (kg) approx
	<i>d</i> _a	<i>D</i> _a	<i>r</i> _{a max}	<i>r</i> _{b max}	
35 TAC 20X+L	46	58	1	0.6	0.375
40 TAC 20X+L	51	63	1	0.6	0.460
45 TAC 20X+L	57	70	1	0.6	0.580
50 TAC 20X+L	62	75	1	0.6	0.625
55 TAC 20X+L	69	84	1	0.6	0.945
60 TAC 20X+L	74	89	1	0.6	1.000
65 TAC 20X+L	79	94	1	0.6	1.080
70 TAC 20X+L	87	104	1	0.6	1.460
75 TAC 20X+L	92	109	1	0.6	1.550
80 TAC 20X+L	99	117	1	0.6	2.110
85 TAC 20X+L	104	122	1	0.6	2.210
90 TAC 20X+L	110	131	1.5	1	2.930
95 TAC 20X+L	115	136	1.5	1	3.050
100 TAC 29X+L	117	134	1	0.6	1.950
100 TAC 20X+L	120	141	1.5	1	3.200
105 TAC 29X+L	122	139	1	0.6	2.040
105 TAC 20X+L	127	150	2	1	4.100
110 TAC 29X+L	127	144	1	0.6	2.120
110 TAC 20X+L	134	158	2	1	5.150
120 TAC 29X+L	139	157	1	0.6	2.940
120 TAC 20X+L	144	168	2	1	5.500
130 TAC 29X+L	150	170	1.5	1	3.950
130 TAC 20X+L	160	187	2	1	8.200
140 TAC 29D+L	158	182	1.5	1	4.200
140 TAC 20D+L	167	198	2	1	8.750
150 TAC 29D+L	172	200	2	1	6.600
150 TAC 20D+L	178	213	2	1	10.700

Remarks Nominal bearing bore and outside diameters for 20X · 20D and 29X · 29D bearing series are the same as those for the NN30 and NNU49 · NN49 bearing series respectively.

Bore Diameter 160 – 280 mm

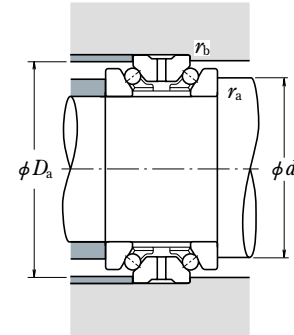
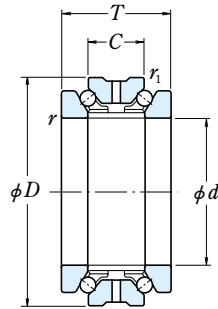

<i>d</i>	Boundary Dimensions (mm)					Basic Load Ratings (N)				Limiting Speeds (min ⁻¹)	
	<i>D</i> ⁽¹⁾	<i>T</i>	<i>C</i>	<i>r</i> _{min}	<i>r</i> _{1 min}	<i>C</i> _a	<i>C</i> _{0a}	<i>C</i> _a	<i>C</i> _{0a}	Grease	Oil
160	220	72	36	2	1	118 000	490 000	12 100	50 000	2 400	2 700
	240	96	48	2.1	1.1	185 000	680 000	18 900	69 500	2 300	2 500
170	230	72	36	2	1	120 000	520 000	12 300	53 000	2 300	2 500
	260	108	54	2.1	1.1	218 000	810 000	22 200	82 500	2 100	2 400
180	250	84	42	2	1	158 000	655 000	16 100	67 000	2 100	2 400
	280	120	60	2.1	1.1	281 000	1 020 000	28 700	104 000	2 000	2 200
190	260	84	42	2	1	161 000	695 000	16 400	71 000	2 000	2 300
	290	120	60	2.1	1.1	285 000	1 060 000	29 000	108 000	1 900	2 100
200	280	96	48	2.1	1.1	204 000	855 000	20 800	87 000	1 900	2 100
	310	132	66	2.1	1.1	315 000	1 180 000	32 000	120 000	1 800	2 000
220	300	96	48	2.1	1.1	210 000	930 000	21 400	95 000	1 800	2 000
240	320	96	48	2.1	1.1	213 000	980 000	21 700	100 000	1 700	1 800
260	360	120	60	2.1	1.1	315 000	1 390 000	32 000	141 000	1 500	1 700
280	380	120	60	2.1	1.1	320 000	1 470 000	32 500	150 000	1 400	1 600

Note ⁽¹⁾ Outside tolerance is f6.

Bearing Numbers	Abutment and Fillet Dimensions (mm)				Mass (kg) approx
	<i>d</i> _a	<i>D</i> _a	<i>r</i> _{a max}	<i>r</i> _{b max}	
160 TAC 29D+L	182	210	2	1	7.000
160 TAC 20D+L	191	228	2	1	13.000
170 TAC 29D+L	192	219	2	1	7.350
170 TAC 20D+L	206	245	2	1	17.700
180 TAC 29D+L	207	238	2	1	10.700
180 TAC 20D+L	220	264	2	1	23.400
190 TAC 29D+L	217	247	2	1	11.200
190 TAC 20D+L	230	274	2	1	24.400
200 TAC 29D+L	230	267	2	1	15.700
200 TAC 20D+L	245	291	2	1	31.500
220 TAC 29D+L	250	287	2	1	17.000
240 TAC 29D+L	270	307	2	1	18.300
260 TAC 29D+L	300	344	2	1	31.500
280 TAC 29D+L	320	364	2	1	33.500

Remarks Nominal bearing bore and outside diameters for **20X · 20D** and **29X · 29D** bearing series are the same as those for the **NN30** and **NNU49 · NN49** bearing series respectively.

Bore Diameter 15 – 60 mm

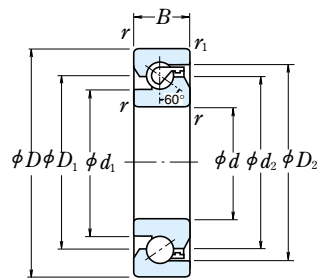

Double-Row Combination

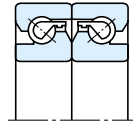

DF

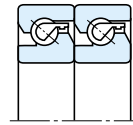

DT

Three-Row Combination

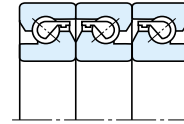

DFD

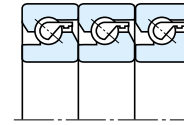

DTD

Four-Row Combination

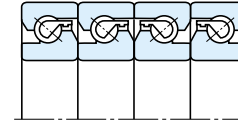

DFF

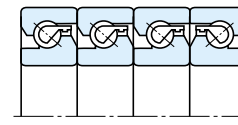

DFT

Dynamic Equivalent Load

$$P_a = X F_r + Y F_a$$

Combination	Two Rows		Three Rows		Four Rows				
	DF	DT	DFD	DTD	DFT	DFF	DFT		
$e = 2.17$	One Row	Two Rows	One Row	Two Rows	Three Rows	One Row	Two Rows	Three Rows	
$F_a/F_r \leq e$	X	1.9	—	1.43	2.33	—	1.17	2.33	2.53
$F_a/F_r > e$	Y	0.55	—	0.77	0.35	—	0.89	0.35	0.26
$F_a/F_r > e$	X	0.92	0.92	0.92	0.92	0.92	0.92	0.92	0.92
$F_a/F_r > e$	Y	1	1	1	1	1	1	1	1

Boundary Dimensions (mm)					Dimensions (mm)				Limiting Speeds ⁽¹⁾ (min ⁻¹)		Bearing Numbers	Mass (kg) approx
d	D	B	r _{min}	r _{1min}	d ₁	d ₂	D ₁	D ₂	Grease	Oil		
15	47	15	1	0.6	27.2	34	34	39.6	6 000	8 000	15 TAC 47B	0.144
17	47	15	1	0.6	27.2	34	34	39.6	6 000	8 000	17 TAC 47B	0.144
20	47	15	1	0.6	27.2	34	34	39.6	6 000	8 000	20 TAC 47B	0.135
25	62	15	1	0.6	37	45	45	50.7	4 500	6 000	25 TAC 62B	0.252
30	62	15	1	0.6	39.5	47	47	53.2	4 300	5 600	30 TAC 62B	0.224
35	72	15	1	0.6	47	55	55	60.7	3 600	5 000	35 TAC 72B	0.31
40	72	15	1	0.6	49	57	57	62.7	3 600	4 800	40 TAC 72B	0.275
	90	20	1	0.6	57	68	68	77.2	3 000	4 000	40 TAC 90B	0.674
45	75	15	1	0.6	54	62	62	67.7	3 200	4 300	45 TAC 75B	0.27
	100	20	1	0.6	64	75	75	84.2	2 600	3 600	45 TAC 100B	0.842
50	100	20	1	0.6	67.5	79	79	87.7	2 600	3 400	50 TAC 100B	0.778
55	100	20	1	0.6	67.5	79	79	87.7	2 600	3 400	55 TAC 100B	0.714
	120	20	1	0.6	82	93	93	102.2	2 200	3 000	55 TAC 120B	1.23
60	120	20	1	0.6	82	93	93	102.2	2 200	3 000	60 TAC 120B	1.16

Note ⁽¹⁾ These values apply when the standard preload (C10) is used.

Basic Load Ratings C _a						Limiting Axial Load					
Sustained by one row DF (N) (kgf)		Sustained by two rows DT, DFD, DFF (N) (kgf)		Sustained by three rows DTD, DFT (N) (kgf)		Sustained by one row DF (N) (kgf)		Sustained by two rows DT, DFD, DFF (N) (kgf)		Sustained by three rows DTD, DFT (N) (kgf)	
21 900	2 240	35 500	3 650	47 500	4 850	26 600	2 710	53 000	5 400	79 500	8 150
21 900	2 240	35 500	3 650	47 500	4 850	26 600	2 710	53 000	5 400	79 500	8 150
21 900	2 240	35 500	3 650	47 500	4 850	26 600	2 710	53 000	5 400	79 500	8 150
28 500	2 910	46 500	4 700	61 500	6 250	40 500	4 150	81 500	8 300	122 000	12 500
29 200	2 980	47 500	4 850	63 000	6 400	43 000	4 400	86 000	8 800	129 000	13 200
31 000	3 150	50 500	5 150	67 000	6 850	50 000	5 100	100 000	10 200	150 000	15 300
31 500	3 250	51 500	5 250	68 500	7 000	52 000	5 300	104 000	10 600	157 000	16 000
59 000	6 000	95 500	9 750	127 000	13 000	89 500	9 150	179 000	18 300	269 000	27 400
33 000	3 350	53 500	5 450	71 000	7 250	57 000	5 800	114 000	11 600	170 000	17 400
61 500	6 300	100 000	10 200	133 000	13 600	99 000	10 100	198 000	20 200	298 000	30 500
63 000	6 400	102 000	10 400	136 000	13 800	104 000	10 600	208 000	21 200	310 000	32 000
63 000	6 400	102 000	10 400	136 000	13 800	104 000	10 600	208 000	21 200	310 000	32 000
67 500	6 850	109 000	11 200	145 000	14 800	123 000	12 600	246 000	25 100	370 000	37 500
67 500	6 850	109 000	11 200	145 000	14 800	123 000	12 600	246 000	25 100	370 000	37 500